

LIST PRICING &  
PRODUCT SPECIFICATIONS  
Effective September 3, 2019



**WOLF HOME PRODUCTS®**

C A B I N E T R Y

**BUILDERS MARK™**  
FROM **WOLF HOME PRODUCTS®**



## BUILDERS MARK FROM WOLF HOME PRODUCTS

### The Budget-Friendly Choice

Whether you're creating a large decorative space or building a small galley kitchen, when you choose Builders Mark cabinets your imagination won't be limited — even if your budget is.

### Exceptional Value

Builders Mark cabinets feature quality wood doors and face frames and come with 1/2" shelves, \*6-way adjustable, fully concealed, self-closing hinges and an easy-clean interior. Plus, you can choose from a variety of smart storage solutions as well as functional and decorative accessories to make any size project your own.

### Buy with Confidence

You can be confident when buying Builders Mark cabinets. In addition to certifications from the Kitchen Cabinet Manufacturers Association (KCMA), Builders Mark comes with a 2-year limited warranty.

## PRODUCT CHARACTERISTICS

### Natural Beauty of Wood

Wood is a natural product with variations in grain, texture and color. As a result of natural conditions, some species will develop characteristics such as burls, pecks, pin burls, shakes, split knots and mineral streaks to name a few. In some instances, even the color will vary greatly within a single piece of wood or cabinet component. A certain amount of variations is allowed and, in fact, is desirable. Doors with these types of characteristics are not to be considered defective. Natural and light finishes will not cover any naturally occurring variation. In addition, all wood will age overtime deepening or mellowing its tone. These characteristics are not to be misinterpreted as defects. Wood is a product of nature- and as such will display natural characteristics and variances that are unique to each and every cut. These characteristics are an integral part of the charm and beauty of real wood.

### Crystalline Water Based Finish

Builders Mark Cabinets feature our Crystalline Water Based Finish which is healthier for our environment and more durable than conventional finishes. Our USA Made low volatile organic compounds (VOC's) clear coats and stains are water based, formaldehyde free, non-yellowing and UV cured for a very durable surface. Builders Mark Crystalline Water Base Finish will exceed the coating life of a conventional conversion varnish by up to 10 years while providing a brighter appearance and more depth of color than conventional coatings

\*Orders from inventory: Conversion from 2-way adjustable to 6-way adjustable hinge is in process via a rolling change. Hinge types may be mixed until inventory change is fully implemented.

# CABINET SPECIFICATIONS

## Wall Cabinet Construction

- A** 1/2" industrial-grade furniture-board top
- B** \*6-way adjustable, fully concealed, self-closing hinge
- C** 1/2" industrial-grade furniture-board adjustable shelf
- D** Low-pressure melamine sides with light maple finish interior
- E** 1/2" industrial-grade furniture-board hanging rail
- F** 1/2" industrial-grade furniture-board bottom
- G** 1/8" laminated MDF cabinet back

- All face frames are 3/4" x 1 1/2" solid-wood, dadoed and joined with screws or doweled

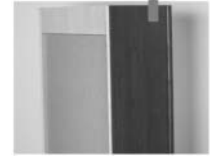
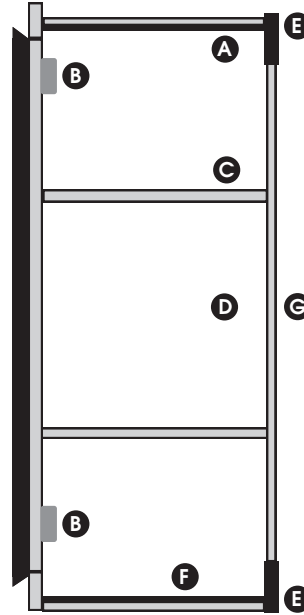

### All single-door cabinets are hinged left.

- Wall cabinets can be flipped during installation for right hinge applications

## Base Cabinet Construction

- 1** 1/2" industrial-grade furniture-board drawer box in light maple stain
- 2** Side-mounted, epoxy-coated, 75 lbs. nylon, lubricated roller glides
- 3** \*6-way adjustable, fully concealed, self-closing hinge
- 4** 1/2" industrial-grade furniture-board, half-depth fixed shelf
- 5** Low-pressure melamine sides with light maple finish interior
- 6** 1/2" industrial-grade furniture-board hanging rail
- 7** 1/8" laminated MDF cabinet back
- 8** 1/2" industrial-grade furniture-board bottom
- 9** 1/2" furniture-board toekick

- All face frames are 3/4" x 1 1/2" solid-wood, dadoed and joined with screws or doweled

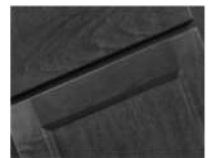
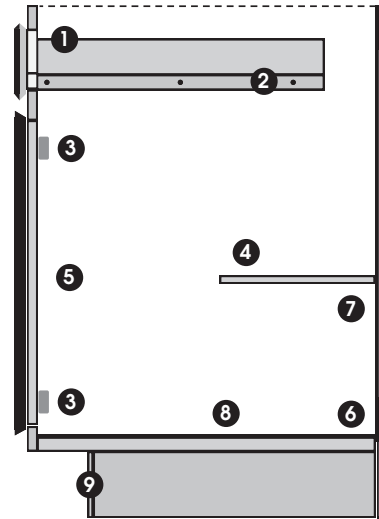

- \*Orders from inventory: Conversion from 2-way adjustable to 6-way adjustable hinge is in process via a rolling change. Hinge types may be mixed until inventory change is fully implemented.

### All single-door cabinets are hinged left.

- Base, tall and vanity cabinet doors will be reversed during installation for right hinge applications

In Stock, Special Order or Truckload

SIERRA STAIN



Espresso (053)      Graphite (057)      Harvest Brown (051)      Nutmeg (056)

- Stained Maple
- Standard overlay
- Mortise and tenon, flat panel door
- Solid wood drawer front
- Durable finish resists scratches, dents and dings

SIERRA PAINT



White (054)      Haze (065)

- Painted solid wood
- Standard overlay
- Mortise and tenon, flat panel door
- Solid wood drawer front
- Durable finish resists scratches, dents and dings

Truckload Only

HIGHLAND



Haze      Maize      Nutmeg      White

- High pressure melamine
- Full overlay
- Slab door with vertical grain
- Slab drawer front with vertical grain
- Durable finish resists scratches, dents and dings

MESA



Espresso

- Stained Maple Veneer
- Full overlay
- Slab door with vertical grain
- Slab drawer front with vertical grain
- Durable finish resists scratches, dents and dings

SIERRA STAIN



Auburn (Truckload only)

- Stained Maple
- Standard overlay
- Mortise and tenon, flat panel door
- Solid wood drawer front
- Durable finish resists scratches, dents and dings

Wall Cabinets – 12" Deep

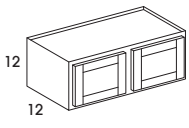
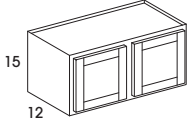
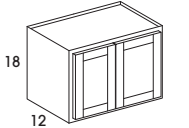
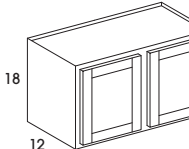
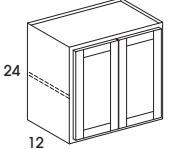
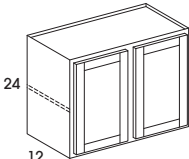
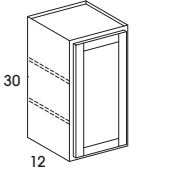
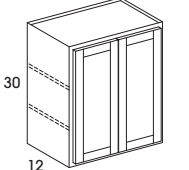
In Stock SKUs		SKU's	cubes	Sierra Stain	Sierra Paint
<b>WALL – 12" HIGH – 12" DEEP</b>					
 <p>12</p>	<ul style="list-style-type: none"> <li>• Two doors with center mullion</li> <li>• Shelves not available</li> <li>• Available widths: 30"-39"</li> </ul>	W3012	4.0	221	254
		W3312	4.0	231	266
		W3612	5.0	249	286
		W3912	6.0	267	307
<b>WALL – 15" HIGH – 12" DEEP</b>					
 <p>15</p>	<ul style="list-style-type: none"> <li>• Two doors with center mullion</li> <li>• Shelves not available</li> <li>• Available widths: 30"-36"</li> </ul>	W3015	4.0	221	254
		W3315	5.0	231	266
		W3615	6.0	249	286
<b>WALL – 18" HIGH – 12" DEEP</b>					
 <p>18</p>	<ul style="list-style-type: none"> <li>• Two butt doors</li> <li>• Shelves not available</li> <li>• Available width: 24"</li> </ul>	W2418DD	4.0	229	263
 <p>18</p>	<ul style="list-style-type: none"> <li>• Two doors with center mullion</li> <li>• Shelves not available</li> <li>• Available widths: 30"-39"</li> </ul>	W3018	5.0	221	254
		W3318	6.0	231	266
		W3618	6.0	249	286
		W3918	7.0	259	298
<b>WALL – 24" HIGH – 12" DEEP</b>					
 <p>24</p>	<ul style="list-style-type: none"> <li>• Two butt doors</li> <li>• One adjustable shelf</li> <li>• Available width: 24"</li> </ul>	W2424DD	5.0	263	302
 <p>24</p>	<ul style="list-style-type: none"> <li>• Two doors with center mullion</li> <li>• One adjustable shelf</li> <li>• Available widths: 30"-39"</li> </ul>	W3024	7.0	240	276
		W3324	7.0	249	286
		W3624	8.0	259	298
		W3924	9.0	270	311
<b>WALL – 30" HIGH – 12" DEEP</b>					
 <p>30</p>	<ul style="list-style-type: none"> <li>• One door</li> <li>• Two adjustable shelves</li> <li>• Hinged left</li> <li>• Available widths: 9"-21"</li> </ul>	W0930	3.0	190	219
		W1230	4.0	205	236
		W1530	5.0	209	240
		W1830	5.0	213	245
		W2130	6.0	245	282
 <p>30</p>	<ul style="list-style-type: none"> <li>• Two butt doors</li> <li>• Two adjustable shelves</li> <li>• Available width: 24"</li> </ul>	W2430DD	7.0	303	348

Wall Cabinets – 12" Deep

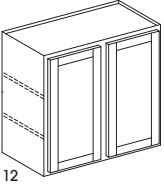
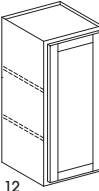
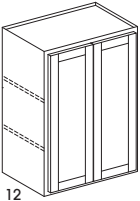
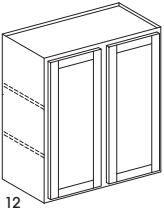
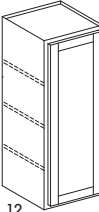
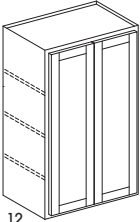
In Stock SKUs		SKU's	cubes	Sierra Stain	Sierra Paint
	<ul style="list-style-type: none"> <li>• Two doors with center mullion</li> <li>• Two adjustable shelves</li> <li>• Available widths: 27"-45"</li> </ul>	W2730	7.0	274	315
		W3030	8.0	294	338
		W3330	9.0	311	358
		W3630	10.0	331	381
		W3930	10.0	362	416
		W4230	11.0	390	449
		W4530	11.0	460	529
<b>WALL - 36" HIGH - 12" DEEP</b>					
	<ul style="list-style-type: none"> <li>• One door</li> <li>• Two adjustable shelves</li> <li>• Hinged left</li> <li>• Available widths: 9"-21"</li> </ul>	W0936	4.0	219	252
		W1236	5.0	233	268
		W1536	6.0	243	279
		W1836	6.0	247	284
		W2136	7.0	280	322
	<ul style="list-style-type: none"> <li>• Two butt doors</li> <li>• Two adjustable shelves</li> <li>• Available width: 24"</li> </ul>	W2436DD	8.0	346	398
	<ul style="list-style-type: none"> <li>• Two doors with center mullion</li> <li>• Two adjustable shelves</li> <li>• Available widths: 27"-42"</li> </ul>	W2736	8.0	317	365
		W3036	9.0	340	391
		W3336	10.0	360	414
		W3636	10.0	379	436
		W3936	11.0	399	459
		W4236	12.0	413	475
<b>WALL - 42" HIGH - 12" DEEP</b>					
	<ul style="list-style-type: none"> <li>• One door</li> <li>• Three adjustable shelves</li> <li>• Hinged left</li> <li>• Available widths: 9"-21"</li> </ul>	W0942	4.0	243	279
		W1242	4.0	257	296
		W1542	5.0	263	302
		W1842	6.0	267	307
		W2142	7.0	309	355
	<ul style="list-style-type: none"> <li>• Two butt doors</li> <li>• Three adjustable shelves</li> <li>• Available width: 24"</li> </ul>	W2442DD	8.0	379	436

Wall Cabinets – 12", 15", and 24" Deep

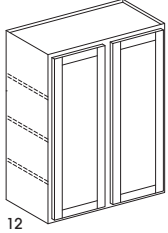
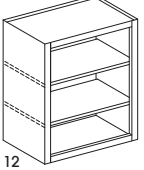
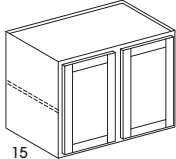
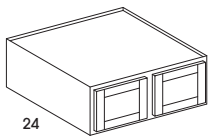
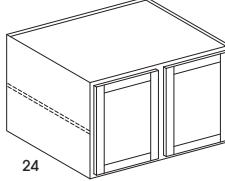
In Stock SKUs		SKU's	cubes	Sierra Stain	Sierra Paint
 <ul style="list-style-type: none"> <li>• Two doors with center mullion</li> <li>• Three adjustable shelves</li> <li>• Available widths: 27"-42"</li> </ul>	W2742	8.0	344	396	
	W3042	10.0	369	424	
	W3342	10.0	392	451	
	W3642	11.0	417	480	
	W3942	11.0	440	506	
	W4242	12.0	466	536	
<b>BOOKCASE CABINET - 30" HIGH - 12" DEEP</b>					
 <ul style="list-style-type: none"> <li>• No door</li> <li>• Matching Interior</li> <li>• Two adjustable shelves</li> <li>• Available widths: 18" and 24"</li> </ul>	BK1830	5.0	292	336	
	BK2430	7.0	358	412	
<b>WALL - 24" HIGH - 15" DEEP</b>					
 <ul style="list-style-type: none"> <li>• Two doors with center mullion</li> <li>• One adjustable shelf</li> <li>• Available width: 30"</li> </ul>	W302415	8.0	276	317	
<b>REFRIGERATOR WALL - 24" DEEP</b>					
 <ul style="list-style-type: none"> <li>• Two doors with center mullion</li> <li>• Shelves not available</li> <li>• Available heights: 12" and 18"</li> <li>• Available width: 36"</li> </ul>	RW3612	6.0	318	366	
	RW3618	10.0	326	375	
 <ul style="list-style-type: none"> <li>• Two doors with center mullion</li> <li>• One adjustable shelf</li> <li>• Available height: 24"</li> <li>• Available width: 36"</li> </ul>	RW3624	12.0	330	380	

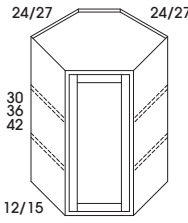
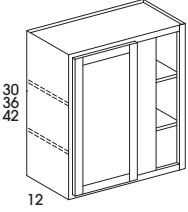
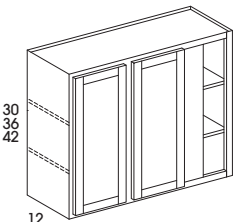

Wall Cabinets – 12" and 15" Deep

In Stock SKUs	SKU's	cubes	Sierra Stain	Sierra Paint
<b>WALL CORNER - DIAGONAL</b>				
 <ul style="list-style-type: none"> <li>• One door</li> <li>• Hinged left</li> <li>• 30" and 36" have two adjustable shelves</li> <li>• 42" has three adjustable shelves</li> <li>• 24" wide will be 12" deep</li> <li>• 27" wide will be 15" deep</li> <li>• Available heights: 30", 36", or 42"</li> </ul>	WDC2430	13.0	386	444
	WDC2436	15.0	506	582
	WDC2442	16.0	604	695
	WDC2742	16.0	641	737
<b>WALL CORNER - BLIND - 12" DEEP</b>				
 <ul style="list-style-type: none"> <li>• One door</li> <li>• Hinged left</li> <li>• 30" and 36" have two adjustable shelves</li> <li>• 42" has three adjustable shelves</li> <li>• Blind cabinets can be pulled 3"</li> <li>• Center stile and blind opening are 6" wide on all sizes</li> <li>• Does not include a panel to cover blind opening</li> <li>• Filler required; order separately</li> <li>• Available widths: 30" and 36"</li> </ul>	WC3030	8.0	294	338
	WC3630	9.0	331	381
	WC3036	9.0	340	391
	WC3636	10.0	379	436
	WC3042	10.0	369	424
	WC3642	11.0	417	480
 <ul style="list-style-type: none"> <li>• Two doors with center mullion</li> <li>• 30" and 36" have two adjustable shelves</li> <li>• 42" has three adjustable shelves</li> <li>• Blind cabinets can be pulled 3"</li> <li>• Center stile and blind opening are 6" wide on all sizes</li> <li>• Does not include a panel to cover blind opening</li> <li>• Filler required; order separately</li> <li>• Available widths: 42"</li> </ul>	WC4230	10.0	360	414
	WC4236	12.0	428	492
	WC4242	12.0	466	536

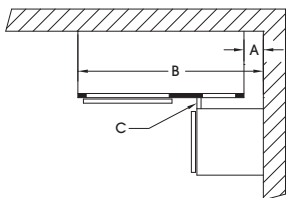

SKU	Cabinet Width	Blind Opening	Center Stile	A			B			C	
				Minimum		Maximum	Minimum		Maximum	No Hardware	1 1/2 Hardware
				SO	FO		SO	FO			
WC30_ _	30"	6"	6"	0"	3/4"	4 1/2"	30"	30 3/4"	34 1/2"	1/2"	2"
WC36_ _	36"						36"	36 3/4"	40 1/2"		
WC42_ _	42"						42"	42 3/4"	46 1/2"		

A = Pull distance from wall  
 B = Cabinet distance from wall  
 C = Minimum filler width

SO = Standard Overlay (Sierra)  
 FO = Full Overlay (Mesa, Highland)

Note: Blind openings are right side; cabinet will be flipped during installation for left blind applications.

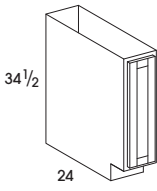
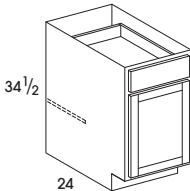
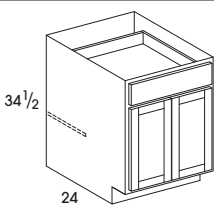
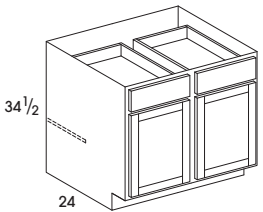

Base Cabinets – 24" Deep

In Stock SKUs	SKU's	cubes	Sierra Stain	Sierra Paint
<b>BASE - 34 1/2" HIGH - 24" DEEP</b>				
 <ul style="list-style-type: none"> <li>• One full-height door</li> <li>• Available width: 9"</li> </ul>	B09	6.0	280	322
 <ul style="list-style-type: none"> <li>• One door</li> <li>• One drawer</li> <li>• One fixed half-depth shelf</li> <li>• Available widths: 12"-21"</li> </ul>	B12	7.0	290	334
	B15	9.0	298	343
	B18	10.0	303	348
	B21	12.0	331	381
 <ul style="list-style-type: none"> <li>• Two butt doors</li> <li>• One drawer</li> <li>• One fixed half-depth shelf</li> <li>• Available width: 24"</li> </ul>	B24DD	13.0	409	470
 <ul style="list-style-type: none"> <li>• Two doors with center mullion</li> <li>• Two drawers</li> <li>• One fixed half-depth shelf</li> <li>• 33"-42" cabinets come with a shipping brace that can be removed during installation</li> <li>• Available width 27"-48"</li> </ul>	B27	15.0	375	431
	B30	17.0	388	446
	B33	18.0	409	470
	B36	20.0	432	497
	B39	21.0	445	512
	B42	23.0	451	519
	B48	23.0	486	559

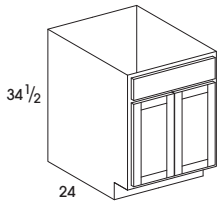
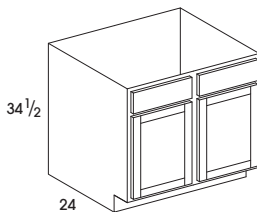
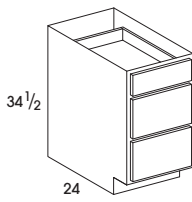
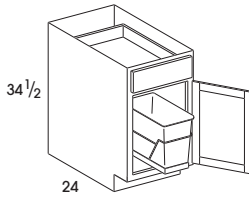
Base Cabinets – 24" Deep

In Stock SKUs		SKU's	cubes	Sierra Stain	Sierra Paint
<b>SINK BASE – 34 1/2" HIGH – 24" DEEP</b>					
 <ul style="list-style-type: none"> <li>• Two butt doors</li> <li>• One false panel</li> <li>• Available width: 24"</li> </ul>	SB24DD	14.0	346	398	
	 <ul style="list-style-type: none"> <li>• Two doors with center mullion</li> <li>• Two false panels</li> <li>• Available widths: 27"-48"</li> </ul>				
	SB27	16.0	356	409	
	SB30	18.0	360	414	
	SB33	19.0	369	424	
	SB36	20.0	388	446	
	SB39	22.0	401	461	
	SB42	23.0	419	482	
	SB48	23.0	456	524	
<b>THREE DRAWER BASE – 34 1/2" HIGH – 24" DEEP</b>					
 <ul style="list-style-type: none"> <li>• Three drawers</li> <li>• Available widths: 12-36"</li> </ul>	DB12	7.0	365	420	
	DB15	9.0	375	431	
	DB18	10.0	379	436	
	DB21	12.0	401	461	
	DB24	13.0	428	492	
	DB30	17.0	481	553	
	DB36	20.0	535	615	
	<b>BASE WASTEBASKET CABINET – 34 1/2" HIGH – 24" DEEP</b>				
 <ul style="list-style-type: none"> <li>• Bottom mounted wastebasket</li> <li>• Includes one black trash can</li> <li>• Available width: 18"</li> </ul>	BWB18	10.0	596	685	

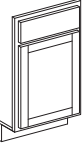
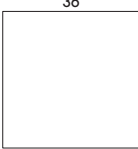
Base Cabinets – 24" Deep

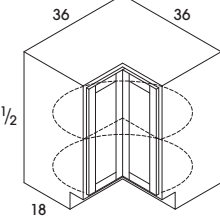
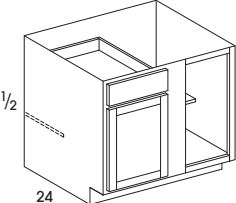
In Stock SKUs	SKU's	cubes	Sierra Stain	Sierra Paint
<b>SINK/RANGE FRONT DIAGONAL</b>				
 <ul style="list-style-type: none"> <li>• One door</li> <li>• One false panel</li> <li>• Order floor and toekick separately</li> <li>• Floor space: 36" x 36" or 42" x 42"</li> </ul>	SCB36FF	2.0	269	309
	SCB42FF	3.0	292	336
<b>SINK/RANGE FRONT DIAGONAL FLOOR</b>				
 <ul style="list-style-type: none"> <li>• Diagonal sink front floor only</li> <li>• Order front and toekick separately</li> </ul>	SCB36DFLR	1.0	97	97
 <ul style="list-style-type: none"> <li>• Diagonal sink front floor only</li> <li>• Order front and toekick separately</li> </ul>	SCB42DFLR	1.0	111	111
<b>BASE CORNER LAZY SUSAN – 34 1/2" HIGH</b>				
 <ul style="list-style-type: none"> <li>• Two rotating shelves attached to doors</li> <li>• Door rotates with shelves</li> <li>• Floor space: 36" x 36"</li> </ul>	LS36	30.0	589	677
<b>BASE CORNER – 34 1/2" HIGH – 24" DEEP</b>				
 <ul style="list-style-type: none"> <li>• One door</li> <li>• One drawer</li> <li>• One fixed half-depth shelf</li> <li>• Center stile: 6"</li> <li>• Blind opening: 9", 12", or 15"</li> <li>• Does not include a panel to cover blind opening</li> <li>• Filler required; order separately</li> <li>• Available width: 36", 39", or 42"</li> </ul>	BC36	20.0	375	431
	BC39	20.0	409	470
	BC42	22.0	445	512

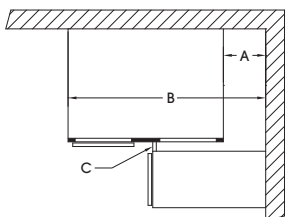

SKU	Cabinet Width	Blind Opening	Center Stile	A			B			C	
				Minimum		Maximum	Minimum		Maximum	No Hardware	1 1/2 Hardware
				SO	FO		SO	FO			
BC36	27"	9"	6"	9"	9 3/4"	13 1/2"	36"	36 3/4"	40 1/2"	1/2"	2"
BC39	33"	12"		6"	6 3/4"	10 1/2"	39"	39 3/4"	43 1/2"		
BC42	39"	15"		3"	3 3/4"	7 1/2"	42"	42 3/4"	46 1/2"		

A = Pull distance from wall  
 B = Cabinet distance from wall  
 C = Minimum filler width

SO = Standard Overlay (Sierra)  
 FO = Full Overlay (Mesa, Highland)

Note: Blind openings are right side: door and drawer can be reversed during installation for left blind application.

Tall Cabinets – 21" and 24" Deep

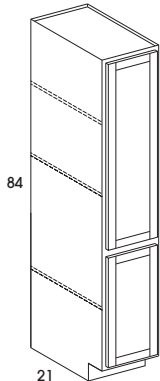
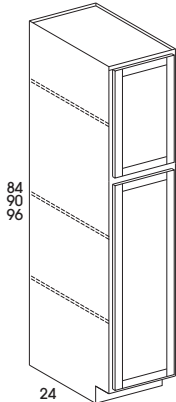
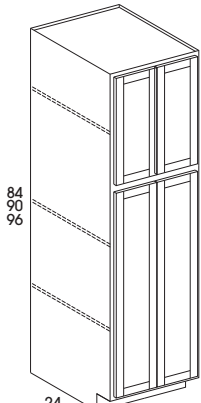
In Stock SKUs	SKU's	cubes	Sierra Stain	Sierra Paint
<b>LINEN CLOSET – 15" WIDE – 21" DEEP</b>				
 <ul style="list-style-type: none"> <li>• Two doors</li> <li>• Three adjustable shelves</li> <li>• Available height: 84"</li> <li>• Available width: 15"</li> </ul>	LC158421	16.0	658	757
<b>UTILITY CABINET – 18" WIDE – 24" DEEP</b>				
 <ul style="list-style-type: none"> <li>• Two doors</li> <li>• Hinged left</li> <li>• Three adjustable shelves</li> <li>• Toekick is installed on all units</li> <li>• Available width: 18"</li> </ul>	U188424	24.0	689	792
	U189024	26.0	732	842
	U189624	37.0	774	890
<b>UTILITY CABINET – 24" WIDE – 24" DEEP</b>				
 <ul style="list-style-type: none"> <li>• Four doors (two sets of butt doors)</li> <li>• Three adjustable shelves</li> <li>• Toekick is installed on all units</li> <li>• Available width: 24"</li> </ul>	U248424DD	32.0	850	978
	U249024DD	34.0	868	998
	U249624DD	39.0	916	1053
<b>UTILITY CABINET SHELF</b>				
<ul style="list-style-type: none"> <li>• For Utility Cabinets: 18" or 24" Wide - 24" Deep</li> <li>• Shelf clips must be ordered separately</li> <li>• Natural Maple laminate</li> </ul>	U1824SHELF	1.0	59	59
	U2424SHELF	1.0	59	59

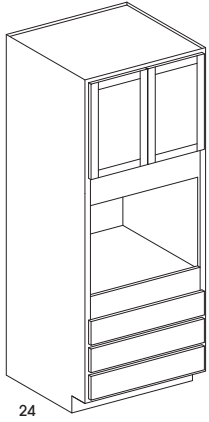

Tall Cabinets – 24" Deep

In Stock SKUs	SKU's	cubes	Sierra Stain	Sierra Paint
<b>OVEN CABINET – 33" WIDE – 24" DEEP</b>				
 <ul style="list-style-type: none"> <li>• Two upper doors with center mullion</li> <li>• Shelves not included</li> <li>• If shelf is desired, order OCSHELF for 96" tall cabinet</li> <li>• Oven Opening: 24" high x 30" wide</li> <li>• Oven cabinet has 1 1/2" stiles running entire height of cabinet</li> <li>• Fillers sold separately to fill gaps between cabinet and appliance</li> <li>• OC inside opening is natural interior</li> <li>• Three Drawers</li> <li>• Drawers may be removed and cut out to create a Double Oven opening</li> <li>• Available width: 33"</li> </ul>	OC339624	47.0	1534	1764
<b>OVEN CABINET SHELF</b>				
<ul style="list-style-type: none"> <li>• Full depth 1/2" shelf to add to upper cabinet of 90" and 96" tall cabinets</li> <li>• Shelf clips must be ordered separately</li> <li>• Natural Maple laminate</li> </ul>	OC33SHELF	1.0	59	59

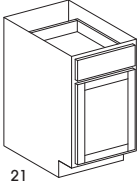
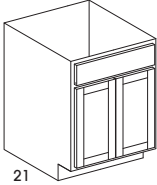
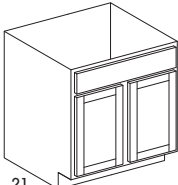
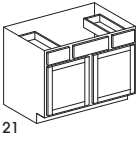
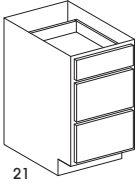
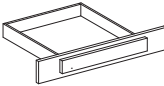
Vanity Cabinets – 21" Deep

In Stock SKUs		SKU's	cubes	Sierra Stain	Sierra Paint
<b>VANITY BASE – 21" DEEP</b>					
	<ul style="list-style-type: none"> <li>• Single door</li> <li>• One drawer</li> <li>• Available widths: 12"-18"</li> </ul>	VB12	6.0	290	334
		VB15	7.0	298	343
		VB18	8.0	303	348
<b>VANITY SINK BASE – 21" DEEP</b>					
	<ul style="list-style-type: none"> <li>• Two butt doors</li> <li>• One false panel</li> <li>• Available width: 24"</li> </ul>	VSB24DD	10.0	379	436
	<ul style="list-style-type: none"> <li>• Two doors with center mullion</li> <li>• One false panel</li> <li>• Available widths: 27"-33"</li> </ul>	VSB27	12.0	356	409
		VSB30	13.0	360	414
		VSB33	14.0	369	424
<b>VANITY SINK BASE WITH DRAWERS – 21" DEEP</b>					
	<ul style="list-style-type: none"> <li>• Two doors with center mullion</li> <li>• Two drawers</li> <li>• One false panel</li> <li>• Cabinets come with a shipping brace that can be removed during installation</li> <li>• Available widths: 36"-48"</li> </ul>	VSDB36	15.0	434	499
		VSDB42	18.0	451	519
		VSDB48	20.0	487	560
<b>VANITY DRAWER BASE – 21" DEEP</b>					
	<ul style="list-style-type: none"> <li>• Three drawers</li> <li>• Available widths: 12"-21"</li> </ul>	VDB12	6.0	378	435
		VDB15	7.0	382	439
		VDB18	8.0	388	446
		VDB21	9.0	419	482
<b>UNDERMOUNT DRAWER – 21" DEEP</b>					
	<ul style="list-style-type: none"> <li>• 36" total width trimmable by 6" both sides</li> <li>• 24" drawer head</li> </ul>	VDT36	3.0	163	187

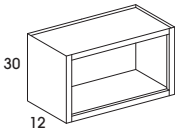
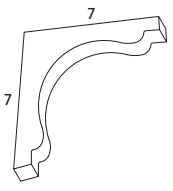
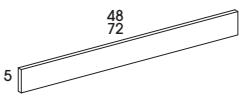
Accessories

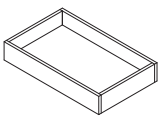
In Stock SKUs		SKU's	cubes	Sierra Stain	Sierra Paint
<b>MICROWAVE WALL CABINET</b>					
 <ul style="list-style-type: none"> <li>Shelf is available: 1/2" x 18" x 27"</li> <li>Available width: 30"</li> </ul>	MWC3018	5.0	354	407	
	MWC30SHELF	5.0	112	112	
<b>CORBEL</b>					
 <ul style="list-style-type: none"> <li>1 1/4" thick solid wood</li> </ul>	CORBEL	1.0	100	115	
<b>STRAIGHT VALANCE</b>					
 <ul style="list-style-type: none"> <li>3/4" thick solid wood</li> <li>Finished on front side only</li> <li>Available widths: 48" and 72"</li> </ul>	V548ST	1.0	71	82	
	V572ST	1.0	82	94	
<b>FILLER</b>					
 <ul style="list-style-type: none"> <li>3/4" thick solid wood</li> <li>FS30 and FS60 may be used for either bases or 30" wall cabinets</li> <li>Finished on the face, and two long sides; long sides receive a lesser finish</li> <li>If you require an end to be exposed we suggest using a valance</li> </ul>	F330	0.1	25	29	
	F342	0.1	49	56	
	F396	0.1	102	117	
	F630	0.2	45	52	
	F642	0.2	86	99	
	F696	0.2	198	228	
<b>PULL-OUT SHELF</b>					
 <ul style="list-style-type: none"> <li>For Base and Tall cabinets</li> <li>Single pull-out shelf, field installed</li> <li>Inside height: 2 1/2"</li> <li>Outside height: 3 1/4"</li> <li>Includes single pull-out shelf with side mounted epoxy glides, front spacer, and screws for installation</li> <li>Available widths: 12"-24"</li> </ul>	POS12	1.0	224	224	
	POS15	1.0	226	226	
	POS18	1.0	230	230	
	POS21	1.0	232	232	
	POS24	1.0	234	234	



Panels

In Stock SKUs	SKU's	cubes	Stain	Paint	
<b>PANELS - MELAMINE</b>					
<ul style="list-style-type: none"> <li>All finished with low pressure melamine</li> </ul>	<ul style="list-style-type: none"> <li><b>P4834</b> - Finished End Panel: 48" x 34" x 1/4" (grain runs with 34")</li> </ul>	P4834	1.0	176	176
	<ul style="list-style-type: none"> <li><b>P4896</b> - Finished End Panel: 48" x 96" x 1/4" (grain runs with 96")</li> </ul>	P4896	1.0	370	370
	<ul style="list-style-type: none"> <li><b>WSKIN30</b> - Finished Panel: 11 1/4" x 30" x 1/8"</li> </ul>	WSKIN30	0.1	44	44
	<ul style="list-style-type: none"> <li><b>WSKIN42</b> - Finished Panel: 11 1/4" x 42" x 1/8"</li> </ul>	WSKIN42	0.1	68	68
	<ul style="list-style-type: none"> <li><b>BSKIN</b> - Finished Panel: 23 1/4" x 34 1/2" x 1/8"</li> </ul>	BSKIN	0.1	95	95
	<ul style="list-style-type: none"> <li><b>REFP24</b> - Finished Refrigerator Panel: 23 13/16" x 96" with 1 1/2" stile</li> </ul>	REFP24	1.0	285	285
	<ul style="list-style-type: none"> <li><b>3/4REFP24</b> - Finished Refrigerator Panel: 24" x 3/4" x 96", one 3/4" x 96" (edge banded)</li> </ul>	3/4REFP24	1.0	398	398
	<ul style="list-style-type: none"> <li><b>DWP3</b> - Dishwasher End Panel with 3" stile</li> </ul>	DWP3	1.0	140	161
<b>DOOR PANELS</b>					
<ul style="list-style-type: none"> <li><b>DWEP30</b> - Decorative End Panel for 30" Wall Cabinet: 11" x 28" x 3/4"</li> </ul>	DWEP30	0.1	133	153	
<ul style="list-style-type: none"> <li><b>DWEP36</b> - Decorative End Panel for 36" Wall Cabinet: 11" x 34" x 3/4"</li> </ul>	DWEP36	0.1	133	153	
<ul style="list-style-type: none"> <li><b>DWEP42</b> - Decorative End Panel for 42" Wall Cabinet: 11" x 40" x 3/4"</li> </ul>	DWEP42	0.1	159	183	
<ul style="list-style-type: none"> <li><b>DEPVB</b> - Decorative End Panel for Vanity Base: 19" x 28" x 3/4"</li> </ul>	DEPVB	0.1	159	183	
<ul style="list-style-type: none"> <li><b>DEPB</b> - Decorative End Panel Base Cabinet: 22" x 28" x 3/4"</li> </ul>	DEPB	0.1	159	183	

Mouldings

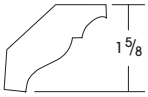
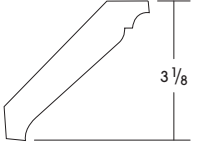
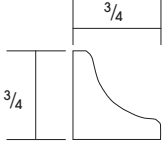
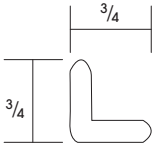
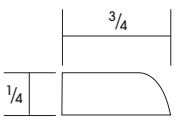
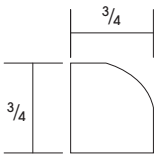
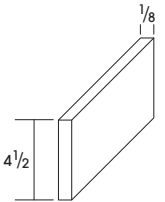
In Stock SKUs	SKU's	cubes	Stain	Paint
<b>CROWN MOULDING - 2 1/2"</b>				
 <ul style="list-style-type: none"> <li>• 8 Feet Long</li> <li>• 2 1/2" Crown</li> <li>• Available in all colors</li> <li>• MDF core wrapped in low pressure melamine</li> </ul>	SMCROWN212	1.0	76	76
<b>CROWN MOULDING - 4 1/2"</b>				
 <ul style="list-style-type: none"> <li>• 8 Feet Long</li> <li>• 4 1/2" Crown</li> <li>• Available in all colors</li> <li>• MDF core wrapped in low pressure melamine</li> </ul>	LGCROWN4.5	1.0	119	119
<b>INSIDE CORNER MOULDING</b>				
 <ul style="list-style-type: none"> <li>• 8 Feet Long</li> <li>• Inside corner</li> <li>• Available in all colors</li> <li>• MDF core wrapped in low pressure melamine</li> </ul>	MICW	1.0	29	29
<b>OUTSIDE CORNER MOULDING</b>				
 <ul style="list-style-type: none"> <li>• 8 Feet Long</li> <li>• Outside corner</li> <li>• Available in all colors</li> <li>• MDF core wrapped in low pressure melamine</li> </ul>	MOCW	1.0	29	29
<b>SCRIBE MOULDING</b>				
 <ul style="list-style-type: none"> <li>• 8 Feet Long</li> <li>• Scribe</li> <li>• Available in all colors</li> <li>• MDF core wrapped in low pressure melamine</li> </ul>	MSW	1.0	21	21
<b>QUARTER ROUND MOULDING</b>				
 <ul style="list-style-type: none"> <li>• 8 Feet Long</li> <li>• Quarter Round</li> <li>• Available in all colors</li> <li>• MDF core wrapped in low pressure melamine</li> </ul>	MQR	1.0	21	21
<b>TOEKICK MOULDING</b>				
 <ul style="list-style-type: none"> <li>• 8 Feet Long</li> <li>• 4 1/2" Toekick</li> <li>• Available in all colors</li> <li>• MDF core wrapped in low pressure melamine</li> </ul>	TOEKICK	1.0	40	40

Wall Cabinets – 12" and 15" Deep

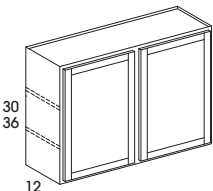
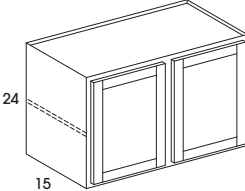
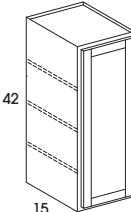
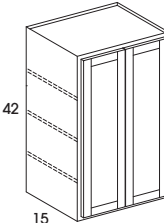
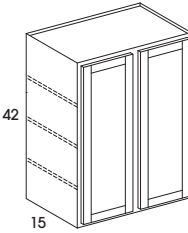
Special Order SKUs – Available with extended lead time		SKU's	cubes	Sierra Stain	Sierra Paint
<b>WALL – 12" DEEP</b>					
	<ul style="list-style-type: none"> <li>• Two doors with center mullion</li> <li>• Two adjustable shelves</li> <li>• Available width: 48"</li> </ul>	W4830	10.0	438	504
		W4836	12.0	449	516
<b>WALL – 15" DEEP</b>					
	<ul style="list-style-type: none"> <li>• Two doors with center mullion</li> <li>• One adjustable shelf</li> <li>• To create flush ends use 1/4" panels: P4834 or P4896</li> <li>• Available width: 36"</li> </ul>	W362415	9.0	297	342
	<ul style="list-style-type: none"> <li>• Single door</li> <li>• Three adjustable shelves</li> <li>• To create flush ends use 1/4" panels: P4834 or P4896</li> <li>• Available widths: 15" and 18"</li> </ul>	W154215	8.0	303	348
		W184215	7.0	307	353
	<ul style="list-style-type: none"> <li>• Two butt doors</li> <li>• Three adjustable shelves</li> <li>• To create flush ends use 1/4" panels: P4834 or P4896</li> <li>• Available width: 24"</li> </ul>	W244215DD	9.0	381	438
	<ul style="list-style-type: none"> <li>• Two doors with center mullion</li> <li>• Three adjustable shelves</li> <li>• To create flush ends use 1/4" panels: P4834 or P4896</li> <li>• Available width: 30"</li> </ul>	W304215	11.0	426	490

Wall Cabinets – 12" and 15" Deep

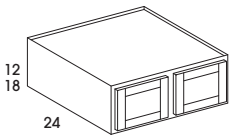
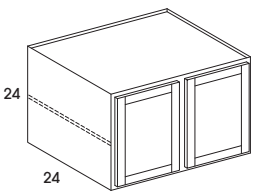
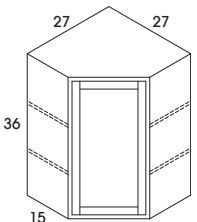
Special Order SKUs – Available with extended lead time		SKU's	cubes	Sierra Stain	Sierra Paint
<b>REFRIGERATOR WALL - 24" DEEP</b>					
 <ul style="list-style-type: none"> <li>• Two doors with center mullion</li> <li>• Shelves not available</li> <li>• Available heights: 12" and 18"</li> <li>• Available width: 39"</li> </ul>	RW3912	7.0	341	392	
	RW3918	10.0	352	405	
 <ul style="list-style-type: none"> <li>• Two doors with center mullion</li> <li>• One adjustable shelf</li> <li>• Available height: 24"</li> <li>• Available width: 39"</li> </ul>	RW3924	13.0	356	409	
<b>DIAGONAL WALL CABINET</b>					
 <ul style="list-style-type: none"> <li>• Single door</li> <li>• Hinged left</li> <li>• Two adjustable shelves</li> </ul>	WDC2736	15.0	540	621	

Sink Front / Base Cabinets

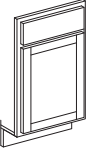
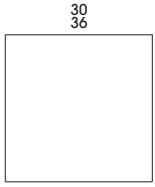
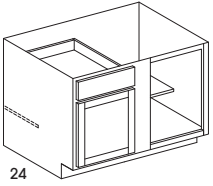
Special Order SKUs – Available with extended lead time		SKU's	cubes	Sierra Stain	Sierra Paint
<b>SINK/RANGE FRONT STRAIGHT</b>					
 <ul style="list-style-type: none"> <li>• Trimmable by 3"</li> <li>• Order floor and toekick separately</li> <li>• Available widths: 30" and 36"</li> </ul>	SF30FF	4.0	236	271	
	SF36FF	5.0	270	311	
<b>SINK FRONT FLOOR</b>					
 <ul style="list-style-type: none"> <li>• Diagonal sink front floor only</li> <li>• Order front and toekick separately</li> </ul>	SF30FLR	1.0	67	67	
	SF36FLR	1.0	80	80	
<b>BASE – 34 1/2" HIGH – 24" DEEP</b>					
 <ul style="list-style-type: none"> <li>• One door</li> <li>• One drawer</li> <li>• One fixed half-depth shelf</li> <li>• Center stile 6"</li> <li>• Blind opening: 18"</li> <li>• Does not include a panel to cover blind opening</li> <li>• Filler required; order separately</li> <li>• Available width: 45"</li> </ul>	BC45	22.0	437	503	

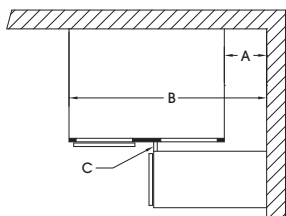

SKU	Cabinet Width	Blind Opening	Center Stile	A			B			C	
				Minimum		Maximum	Minimum		Maximum	No Hardware	1 1/2 Hardware
				SO	FO		SO	FO			
BC45	45"	18"	6"	0"	3/4"	4 1/2"	45"	45 3/4"	49 1/2"	1/2"	2"

A = Pull distance from wall  
 B = Cabinet distance from wall  
 C = Minimum filler width

SO = Standard Overlay (Sierra)  
 FO = Full Overlay (Mesa, Highland)

Note: Blind openings are on the right side; Door and drawer can be reversed during installation for left blind applications.

Oven Cabinet / Decorative End Panels

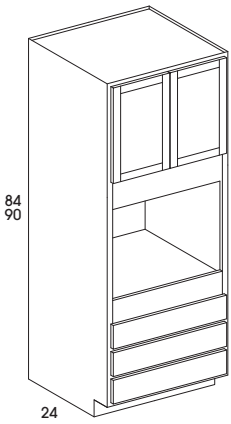
Special Order SKUs - Available with extended lead time		SKU's	cubes	Sierra Stain	Sierra Paint
<b>OVEN CABINET - 33" WIDE - 24" DEEP</b>					
 <ul style="list-style-type: none"> <li>• Two upper doors with center mullion</li> <li>• Shelves not included</li> <li>• If shelf is desired, order OCSHELF for 90" tall cabinets</li> <li>• Oven Opening: 24" high x 30" wide</li> <li>• Oven cabinet has 1 1/2" stiles running entire height of cabinet</li> <li>• Fillers sold separately to fill gaps between cabinet and appliance</li> <li>• OC inside opening is natural interior</li> <li>• Three Drawers</li> <li>• Drawers may be removed and cut out to create a Double Oven opening</li> <li>• Available width: 33"</li> </ul>	OC338424	41.0	1321	1519	
	OC339024	44.0	1424	1638	
<b>OVEN CABINET SHELF</b>					
<ul style="list-style-type: none"> <li>• Full depth 1/2" shelf to add to upper cabinet of 90" and 96" tall cabinets</li> <li>• Shelf clips must be ordered separately</li> <li>• Natural Maple laminate</li> </ul>	OC33SHELF	1.0	59	59	
<b>DECORATIVE END PANELS - TALL CABINET (ACTUAL DOORS)</b>					
<ul style="list-style-type: none"> <li>• <b>DEPTB</b> - Bottom section for all Tall cabinet</li> </ul>	DEPTB	0.1	237	273	
<ul style="list-style-type: none"> <li>• <b>DEPT84</b> - Top section for 84" Tall cabinet</li> </ul>	DEPT84	0.1	341	392	
<ul style="list-style-type: none"> <li>• <b>DEPT90</b> - Top section for 90" Tall cabinet</li> </ul>	DEPT90	0.1	393	452	
<ul style="list-style-type: none"> <li>• <b>DEPT96</b> - Top section for 96" Tall cabinet</li> </ul>	DEPT96	0.1	445	512	

**ORDERING GUIDELINES**

The products shown in this brochure are available for special order only in full-truck quantities. Truckload orders ship directly from Wolf's manufacturing facility. Please review the requirements below in order to participate in our truckload program.

**Product Mix**

Truckload orders must consist of a single door style in one or two colors. If two colors are ordered, quantities must be split as evenly as possible between the two colors. Please be sure to double check your orders to ensure you have not missed any items.

**Quantity**

Truckload orders must fall between a minimum of 2,200 cubes (including panels, mouldings and accessories) and a maximum of 3,100 cubes. Any ordered material exceeding the maximum will not be included in the final order. In-stock material exceeding the maximum can be ordered out of warehouse using your warehouse multiplier. Any truckload only style and finish combinations cannot be ordered out of warehouse.

**Timeframe**

Please confirm current lead times with your Wolf Sales Consultant. Lead times may vary due to current production capabilities and product demand. Turnaround time begins once the order confirmation is approved. The delivery date provided on the confirmation is an estimated date available. If you would like a later date, please communicate with Wolf Customer Care to update your order. Once the order confirmation is approved, the delivery date cannot be changed without penalty. Delivery date changes can only be made in the event of inclement weather. Any non-weather related delivery change will result in additional freight charges where applicable. Customer Care will contact you within 48 hours with your delivery date.

**Freight**

Truckload orders are FOB from our manufacturing facility. Please request a shipping estimate early in the process to ensure you understand all costs associated with your order. If there is a delay between your estimate and order placement, please ask for an updated shipping estimate.

**Changes**

Once your order confirmation has been approved, the order has been placed into production. No changes can be made after you have approved your order.

**Touch Up Kits**

Touch up kits are available for purchase and will ship via FedEx. (They cannot ship on the truck with your truckload order.) We will coordinate the timing of your touch up kits to arrive near the delivery time of your truckload.

**Unload Time**

You will be contacted with a delivery time. Please be prepared to unload the truck immediately upon arrival. There is a two-hour window allowed for unloading. Detention fees will be charged when exceeding the two-hour window. NOTE: When accepting a Builders Mark direct truck, please have adequate manpower on site to unload in the two (2) hour delivery window. Independent drivers do not assist in unloading. Any time incurred beyond the initial two hours will be charged at \$75.00 per hour.

**Moulding Quantities**

SKU	Pieces/Carton
F330	10
F342	10
F396	10
F630	10
F642	10
F696	6
LGCROWN4.5 - Large Crown	8
MCW - Inside Corner	25
MOCW - Outside Corner	25
MQR - Quarter Round	25
MSW - Scribe	20
SMCROWN212	10
TOEKICK	20
V548ST	10
V572ST	10
WSKIN30	10
WSKIN42	10
CORBEL	20
BUMPERPAD	1900

## Universal Design Specifications

Builders Mark Cabinets are also available in Universal Design Specifications.

**These Universal Design cabinets are available only on Truckload Orders.**

Please work with your Wolf Sales Consultant or Wolf Customer Care to determine your delivery date.

### What is ADA Compliance vs. Universal Design?

ADA compliant cabinets are designed to meet the needs of people with disabilities per the Americans with Disabilities Act. Builders Mark Cabinets offers a reduced height product that may be used in your ADA or UD design. Although product choice does need to be considered, designing for ADA and UD is not just about product, it's mainly about design principles and building codes. For more information about ADA regulations, please visit [www.ADA.gov](http://www.ADA.gov).

ADA compliance is based on the overall height of the workspace, clear floor space, knee clearance and toe clearance combined. All of these elements must be applied together and accurately for your design to be considered ADA compliant. Codes will vary and it is important for you to understand your local codes before starting your design.

Universal Design, also known as Aging in Place Design, is a much broader concept. The goal is to create an environment that is usable, to the greatest extent possible, by people of any age or ability without the need for a special design or adaptation. In order to be considered UD, your design must consider the space needed for approach, reach, manipulation and overall use regardless of the user's body size, posture or mobility.

Universal Design Builders Mark cabinets are 32" in height and have a 4 $\frac{1}{2}$ " toekick.

All other product specifications are the same as our standard cabinet.

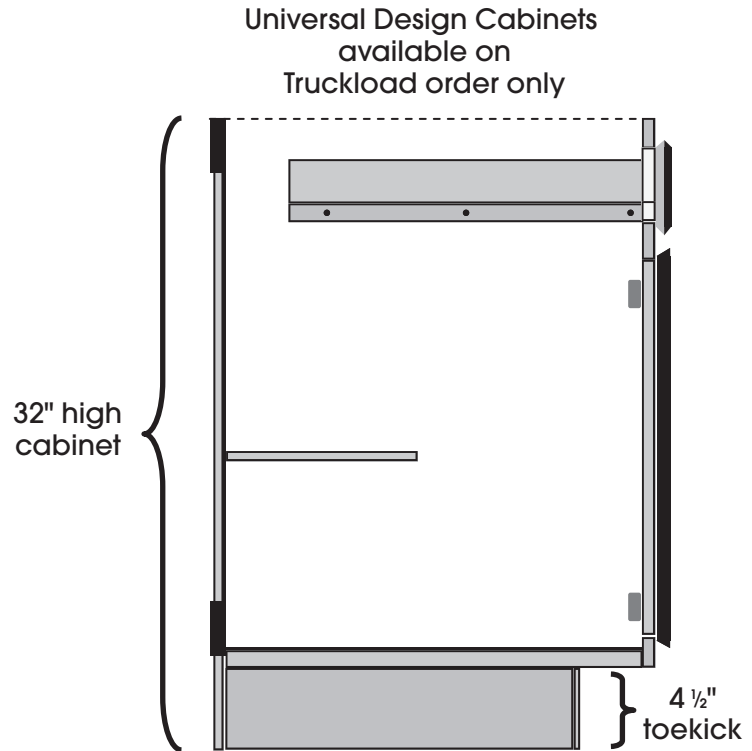

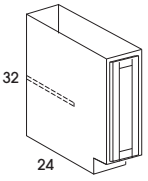
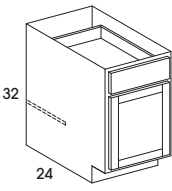
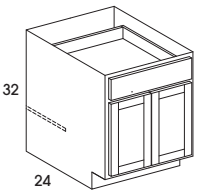
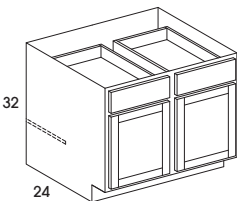
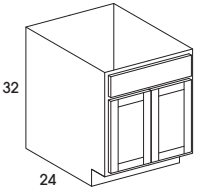
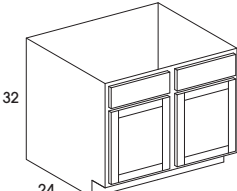

Universal Design Cabinets – 24" Deep

Truckload Only		SKU's	cubes	Sierra Stain - Highland - Mesa	Sierra Paint
<b>BASE - 32" HIGH - 24" DEEP</b>					
 <ul style="list-style-type: none"> <li>• One full height door</li> <li>• Hinged left</li> <li>• 1 fixed half-depth shelf</li> <li>• Available width: 9"</li> </ul>	B09UD	6.0	295	339	
 <ul style="list-style-type: none"> <li>• One door hinged left</li> <li>• One drawer</li> <li>• Available widths: 12"-21"</li> </ul>	B12UD	7.0	303	348	
	B15UD	9.0	312	359	
	B18UD	10.0	317	365	
	B21UD	12.0	346	398	
 <ul style="list-style-type: none"> <li>• Two butt doors</li> <li>• One drawer</li> <li>• One fixed half-depth shelf</li> <li>• Available width: 24"</li> </ul>	B24DDUD	13.0	430	495	
 <ul style="list-style-type: none"> <li>• Two doors with center mullion</li> <li>• Two drawers</li> <li>• One fixed half-depth shelf</li> <li>• 33"-42" cabinets come with a shipping brace that can be removed during installation</li> <li>• Available widths: 27"-42"</li> </ul>	B27UD	15.0	393	452	
	B30UD	17.0	407	468	
	B33UD	18.0	430	495	
	B36UD	20.0	454	522	
	B39UD	21.0	468	538	
	B42UD	23.0	473	544	
<b>SINK BASE - 32" HIGH - 24" DEEP</b>					
 <ul style="list-style-type: none"> <li>• Two butt doors</li> <li>• One false panel</li> <li>• Available width: 24"</li> </ul>	SB24DDUD	14.0	365	420	
 <ul style="list-style-type: none"> <li>• Two doors with center mullion</li> <li>• Two false panels</li> <li>• Available widths: 27"-42"</li> </ul>	SB27UD	16.0	374	430	
	SB30UD	17.0	379	436	
	SB33UD	19.0	389	447	
	SB36UD	20.0	407	468	
	SB39UD	22.0	422	485	
	SB42UD	23.0	439	505	

## Universal Design Cabinets – 21" and 24" Deep

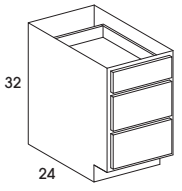
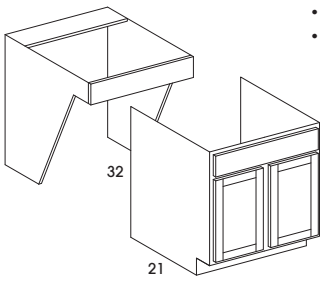
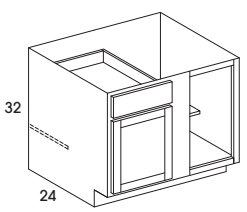
Truckload Only		SKU's	cubes	Sierra Stain - Highland - Mesa	Sierra Paint
<b>THREE DRAWER BASE – 32" HIGH – 24" DEEP</b>					
 <ul style="list-style-type: none"> <li>• Three drawers</li> <li>• Available widths: 12"-36"</li> </ul>	DB12UD	7.0	384	442	
	DB15UD	9.0	393	452	
	DB18UD	10.0	397	457	
	DB21UD	12.0	422	485	
	DB24UD	13.0	450	518	
	DB30UD	17.0	505	581	
	DB36UD	20.0	562	646	
<b>REMOVABLE FRONT CABINETS – 32" HIGH – 24" DEEP</b>					
 <ul style="list-style-type: none"> <li>• Includes both pieces</li> <li>• Available widths" 30" and 36"</li> </ul>	SB30REMUD	20.0	570	656	
	SB36REMUD	23.0	599	689	
<b>BASE CORNER – 32" HIGH – 24" DEEP</b>					
 <ul style="list-style-type: none"> <li>• One door</li> <li>• One drawer</li> <li>• One fixed half-depth shelf</li> <li>• Center stile: 6" Blind opening: 9", 12", or 15"</li> <li>• Does not include a panel to cover blind opening</li> <li>• Filler required; order separately</li> <li>• Available widths: 36", 39", or 42"</li> </ul>	BC36UD	20.0	393	452	
	BC39UD	20.0	430	495	
	BC42UD	22.0	468	538	

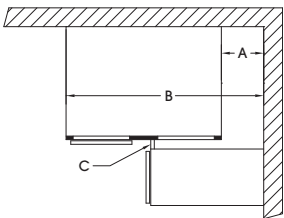

SKU	Cabinet Width	Blind Opening	Center Stile	A			B			C	
				Minimum		Maximum	Minimum		Maximum	No Hardware	1 1/2 Hardware
				SO	FO		SO	FO			
BC36UD	27"	9"	6"	9"	9 3/4"	13 1/2"	36"	36 3/4"	40 1/2"	1/2"	2"
BC39UD	33"	12"		6"	6 3/4"	10 1/2"	39"	39 3/4"	43 1/2"		
BC42UD	39"	15"		3"	3 3/4"	7 1/2"	42"	42 3/4"	46 1/2"		

A = Pull distance from wall  
 B = Cabinet distance from wall  
 C = Minimum filler width

SO = Standard Overlay (Sierra)  
 FO = Full Overlay (Mesa, Highland)

Note: Blind openings are right side; door and drawer can be reversed during installation for left blind application.

Universal Design Cabinets – 21" Deep

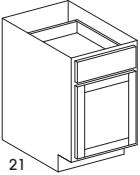
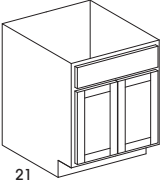
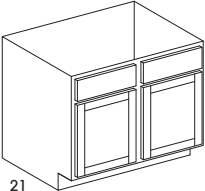
Truckload Only		SKU's	cubes	Sierra Stain - Highland - Mesa	Sierra Paint
<b>VANITY BASE - 32" HIGH - 21" DEEP</b>					
 <ul style="list-style-type: none"> <li>• Single door</li> <li>• One drawer</li> <li>• Available widths: 12"-18"</li> </ul>	VB12UD	6.0	303	348	
	VB15UD	7.0	312	359	
	VB18UD	8.0	317	365	
<b>VANITY SINK BASE - 32" HIGH - 21" DEEP</b>					
 <ul style="list-style-type: none"> <li>• Two butt doors</li> <li>• One false panel</li> <li>• Available width: 24"</li> </ul>	VSB24DDUD	10.0	397	457	
 <ul style="list-style-type: none"> <li>• Two doors with center mullion</li> <li>• Two false panels</li> <li>• Available widths: 27"-33"</li> </ul>	VSB27UD	12.0	374	430	
	VSB30UD	13.0	379	436	
	VSB33UD	14.0	389	447	

Universal Design Cabinets – 21" Deep

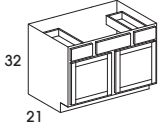
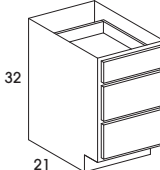
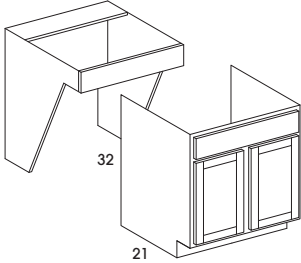
Truckload Only		SKU's	cubes	Sierra Stain - Highland - Mesa	Sierra Paint
<b>VANITY SINK BASE WITH DRAWERS – 32" HIGH – 21" DEEP</b>					
 <ul style="list-style-type: none"> <li>• Two doors with center mullion</li> <li>• Two drawers</li> <li>• One false panel</li> <li>• Cabinets come with a shipping brace that can be removed during installation</li> <li>• Available widths: 36"-48"</li> </ul>	VSDB36UD	15.0	456	524	
	VSDB42UD	18.0	473	544	
	VSDB48UD	20.0	513	590	
<b>VANITY THREE DRAWER BASE – 32" HIGH – 21" DEEP</b>					
 <ul style="list-style-type: none"> <li>• Three drawers</li> <li>• Available widths: 12-21"</li> </ul>	VDB12UD	6.0	396	455	
	VDB15UD	7.0	401	461	
	VDB18UD	8.0	407	468	
	VDB21UD	9.0	439	505	
<b>REMOVABLE FRONT CABINETS – 32" HIGH – 21" DEEP</b>					
 <ul style="list-style-type: none"> <li>• Includes both pieces</li> <li>• Available widths: 30" and 36"</li> </ul>	VSB30REMUD	16.0	570	656	
	VSB36REMUD	18.0	599	689	

Hardware & Parts / Touch Up Kits

Hardware & Parts

SKU	Number	Price	Quantities
<b>HINGE</b>			
Hinge	1647601	6	Each
<b>6-WAY ADJUSTABLE HINGE FOR 24" WIDE CABINET</b>			
HINGE6	1914194	6	Each
<b>HINGE SCREW</b>			
HINGESCREW	1647600	0.07	Each
<b>SHELF CLIP</b>			
SHCLIP	1647608	0.28	Each
<b>SET OF R/L GLIDES FOR STANDARD BASE</b>			
BGLIDE	1647793	28	Set of 2
<b>SET OF R/L GLIDES FOR VANITY BASE</b>			
VGLIDE	1647809	28	Set of 2
<b>BUMPER PADS – SHEET OF 50</b>			
BUMPERPAD	1647673	7	50/pk

Touch Up Kits

SKUs and Finish Reference	Number	Price	Quantities
<b>PINT OF STAIN OR PAINT</b>			
052 STAINPT – Auburn Stain	1647596	42	Pint
053 STAINPT – Espresso Stain	1647230	42	Pint
057 STAINPT – Graphite Stain	2884533	42	Pint
051 STAINPT – Harvest Brown Stain	1647414	42	Pint
061 STAINPT – Maize Stain	3028817	42	Pint
056 STAINPT – Nutmeg Stain	2770045	42	Pint
054 PAINTPT – White Paint	1915217	42	Pint
060 PAINTPT – Haze Paint	3028567	42	Pint
065 PAINTPT – Haze Paint	3028567	42	Pint
<b>TOUCH UP KIT</b>			
052 TUKIT – Auburn Stain	1647598	42	Each
053 TUKIT – Espresso Stain	1647232	42	Each
057 TUKIT – Graphite Stain	2884534	42	Each
051 TUKIT – Harvest Brown Stain	1647416	42	Each
061 TUKIT – Maize Stain	3028816	42	Each
056 TUKIT – Nutmeg Stain	2770046	42	Each
054 TUKIT – White Paint	1915216	42	Each
060 TUKIT – Haze Paint	3028566	42	Each
065 TUKIT – Haze Paint	3028566	42	Each
<b>CANS OF SPRAY</b>			
STAINTOPSPRAY – Top coat for stains	1647650	44	13 oz.
053 STAINSPRAY – Espresso Stain	3027123	44	13 oz.
054 PAINTSPRAY – White Paint	1915218	44	13 oz.
060 PAINTSPRAY – Haze Paint	3028568	44	13 oz.
065 PAINTSPRAY – Haze Paint	3028568	44	13 oz.

**Builders Mark 2-Year Limited Warranty**

Builders Mark Cabinets from Wolf Home Products have been manufactured under the highest standards of quality and workmanship.

**2-Year Limited Warranty**

Wolf Home Products warrants that its cabinets and related components ("Products") will be free of all defects in materials and workmanship for two (2) years from date of purchase under normal use subject to the exclusions contained herein.

Warrantor's obligation here under is valid only for the standard application in which the Products are used when properly installed in accordance with applicable building codes, conditions, industry acceptable standards and Warrantor's installation instructions. This warranty is not valid for Products used for any purpose other than the purpose for which it was originally intended. Warrantor shall not be responsible for any losses sustained or costs incurred that are reported after the expiration of the two (2) year warranty period.

Warrantor's sole responsibility, and the buyer's sole and exclusive remedy, shall be the refund or replacement, at no additional charge to buyer, or the defective Product. Warrantor shall not be responsible for any consequential damages, lost profits, or any other costs or damages all of which are specifically excluded, including without limitation labor, installation, shipping, transport, disposal, or any costs associated with the Product including without limitation plumbing, walls, flooring, fixtures, gas or electric appliances, or countertops, all of which are specifically excluded.

This warranty does not cover claims arising out of natural characteristics of some wood to split, warp or twist, or natural variations in grain, mineral streaks, knots and color.

This warranty does not cover claims arising out of misuse, physical abuse, alteration, accident, improper care in performing necessary upkeep after installation, acts of God, acts of war, vermin or insect infestation, or other chemical or biological factors.

Failure to follow written instructions, restrictions or warnings supplied with the Product shall make the Warrantor's obligation hereunder null and void and of no further effect.

THIS WARRANTY IS THE EXCLUSIVE WARRANTY OF WOLF HOME PRODUCTS AND IS IN LIEU OF AND WOLF HOME PRODUCTS DISCLAIMS ALL OTHER WARRANTIES, EXPRESS OR IMPLIED, INCLUDING IMPLIED WARRANTIES OF MERCHANTABILITY AND FITNESS FOR A PARTICULAR PURPOSE. Some states do not allow the exclusion or limitation of incidental or consequential damages, so the above limitations or exclusions may not apply to you. This warranty gives you specific legal rights, and you may also have other rights which vary from state to state.

To submit a claim under this warranty, contact your Builders Mark cabinets dealer or send a letter explaining the defect along with photo and a dated sales receipt as proof of purchase to the address below.

**Builders Mark Cabinets**  
**Attn: Warranty Claims**  
**20 West Market Street**  
**York, PA 17401**  
**phone 800-234-9653**  
**fax 717-792-4052**  
**wolfcabinetswarranty@wolfhomeproducts.com**  
**wolfhomeproducts.com**  
 ©2016 Wolf Home Products.  
 All Rights Reserved.







Wolf Home Products® is an innovator in the building products industry. We've cultivated more than 175 years of business experience into a total satisfaction guarantee. With our vast inventory of kitchen and bath, outdoor living and building products, we deliver your orders in a fraction of the time and ensure you get unparalleled value — when and where you need it. Wolf stands behind our service because, above all, Wolf stands behind you.



Kitchen & Bath



Outdoor Living



Building Products

[wolfhomeproducts.com](http://wolfhomeproducts.com) | © 2019 Wolf Home Products. All Rights Reserved.

All photos and colors are representative of product. Please review an actual product sample with your dealer before making your final selection.

